

AMD Direct, Inc.

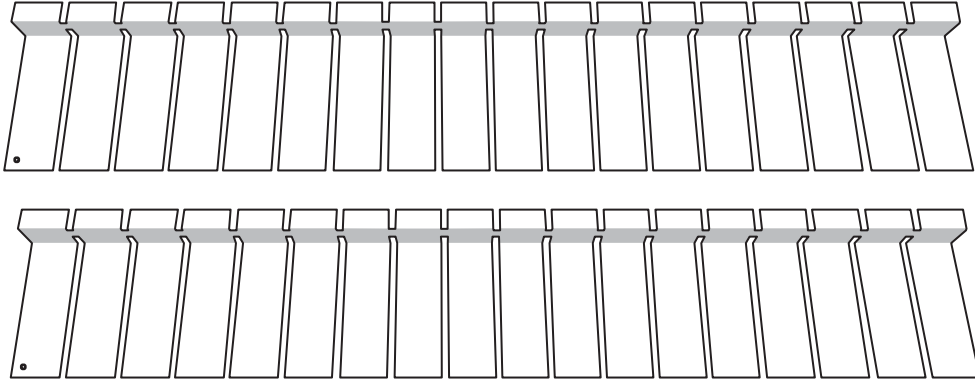

Models: FLEXFRAME-SS
FLEXFRAME-SS3
FLEXFRAME PRO3

Universal brackets for use with blocks, bricks or pavers to support round, linear pans and flat disc fire pit pans

Installation Instructions

**IF YOU CANNOT READ OR UNDERSTAND THESE INSTALLATION INSTRUCTIONS
DO NOT ATTEMPT TO INSTALL OR OPERATE THIS PRODUCT**

CALIFORNIA PROPOSITION 65



WARNING

This product can expose you to Chromium, which is known to the state of California to cause cancer and birth defects or other reproductive harm.
(For more information, go to www.p65warnings.ca.gov)

NATIONAL
FIREPLACE
INSTITUTE



CERTIFIED
www.nficertified.org

We recommend that our gas hearth products be installed and serviced by professionals who are certified in the U.S. by the National Fireplace Institute® (NFI) as NFI Gas Specialists.

PLEASE RETAIN THIS MANUAL FOR FUTURE REFERENCE

FLEXFRAME-SS: Constructed of 16 gage 304 stainless steel. Engineered to protect against the outdoor elements including salt water environment.

FLEXFRAME PRO3: Constructed of 14 gage 304 stainless steel. Engineered to protect against the outdoor elements including salt water environment. The FLEXFRAME PRO3 allows the user to fill a opening 5-inches larger than the OD of a round, linear, flat or square fire pit.

DESCRIPTION: FLEXFRAME-SS kits comes shipped in two pieces, 44-inches long. FLEXFRAME-SS3; comes with three pieces 44-inches long. FLEXFRAME PRO3 comes with three pieces, 44-inches long. Each piece can be bent or cut to fit any shape (square, linear or round). It provides the means to support a fire pit inside of an enclosure which enables a service technician the ability to remove the media and easily lift the fire pit out for service.

SPECIFICATIONS

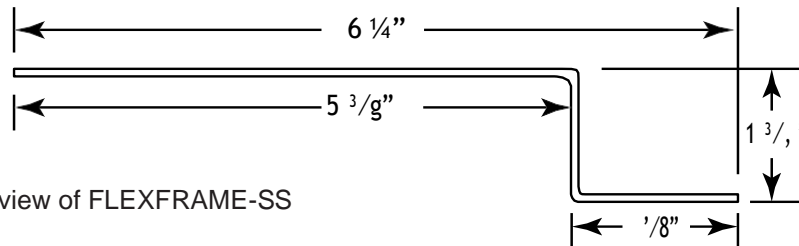

Fig. 1 End view of FLEXFRAME-SS

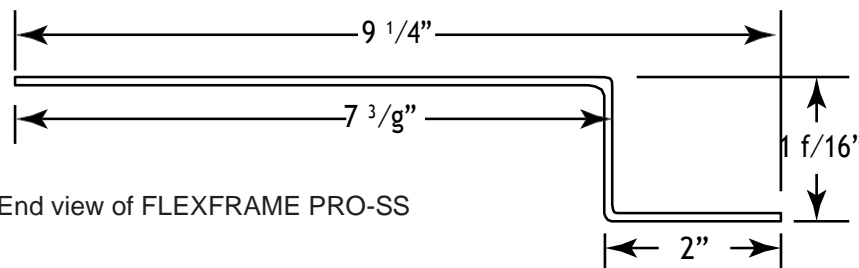

Fig. 1A End view of FLEXFRAME PRO-SS

INSTALLATION

READ THESE INSTRUCTIONS COMPLETELY THROUGH BEFORE PROCEEDING WITH INSTALLATION

STEP 1: Determine if the FLEXFRAME will work for your application. Measure the outer dimension of the fire pit and compare it to the inner dimension of the enclosure. The FLEXFRAME protrudes outward approximately 7/8" for FLEXFRAME-SS and FLEXFRAME-SS3. The FLEXFRAME PRO3 protrudes 2" on the inside of the enclosure to provide a lip to sit the fire pit in place. **NOTE:** If an optional log set is purchased, additional support (i.e. blocks stacked underneath the center of the fire pit) may be required to support the extra weight.

STEP: 2 Refer to the installation manual of the fire pit you are installing to ensure you maintain proper clearances to the ground. Lay the paver's or blocks to build your enclosure. When you have reached the minimum height (per fire pit manual) inside the enclosure install the FLEXFRAME as shown in Fig. 2 or Fig 3. Ensure the FLEXFRAME slides in as far as possible until it stops at the first bend.

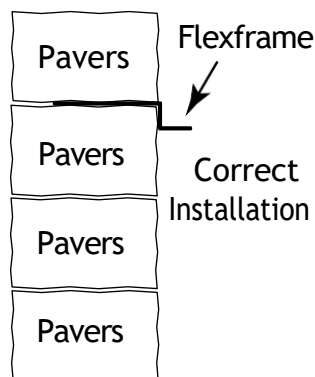

Fig. 2 Correct FLEXFRAME orientation

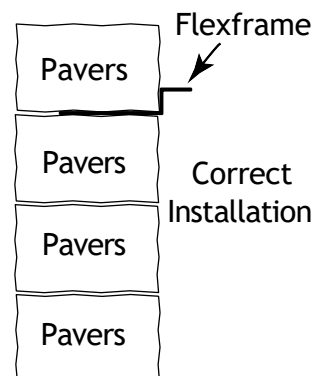

Fig. 3 Correct FLEXFRAME orientation

If you are building a round paver enclosure the FLEXFRAME will easily bend by hand in virtually any shape you prefer (Fig. 4).

CAUTION: Wear gloves when forming the FLEXFRAME by hand. The flex frame could “spring” back and pinch fingers. In addition it is a good idea not to form the FLEXFRAME until you are ready to lay it into place. This will allow your block or pavers to hold it into place as you are completing the top row. **Note:** If you feel the need for additional strengthening then add block adhesive to the same layer with the FLEXFRAME for extra support.

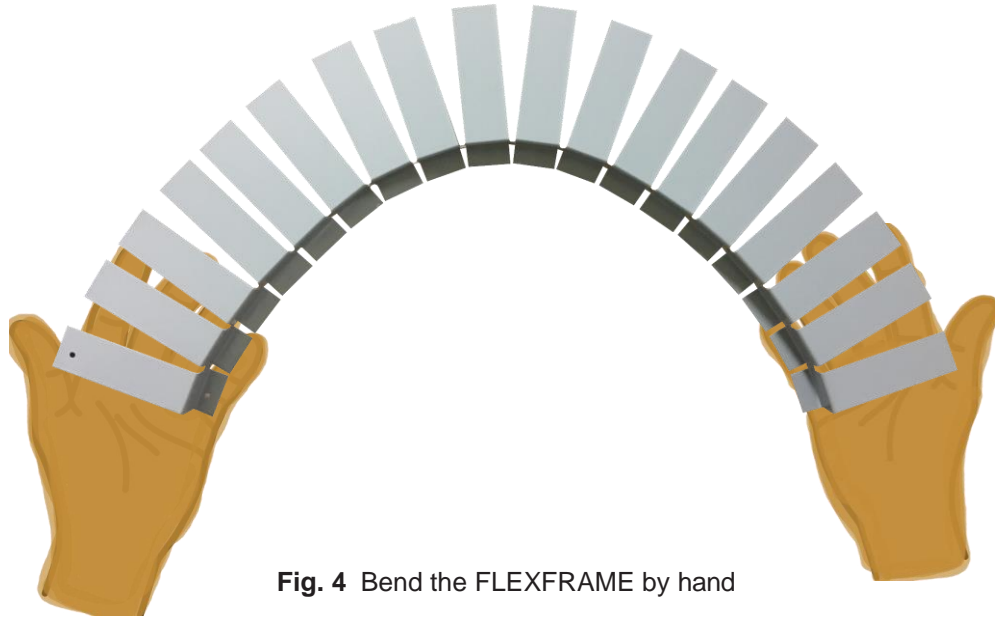

Fig. 4 Bend the FLEXFRAME by hand

STEP 3: Form or lay the FLEXFRAME inside the entire enclosure area. It is permissible to cut the FLEXFRAME to fit your enclosure, however, it is not permissible to only use “just enough” pieces to support a pan (See Fig. 5 and Fig. 6 for examples).

NOTE: Firegear Outdoors will not be liable for FLEXFRAME installations not installed correctly. Once the FLEXFRAME is in place the installation is complete. Proceed to Step 4 for fire pit installation.

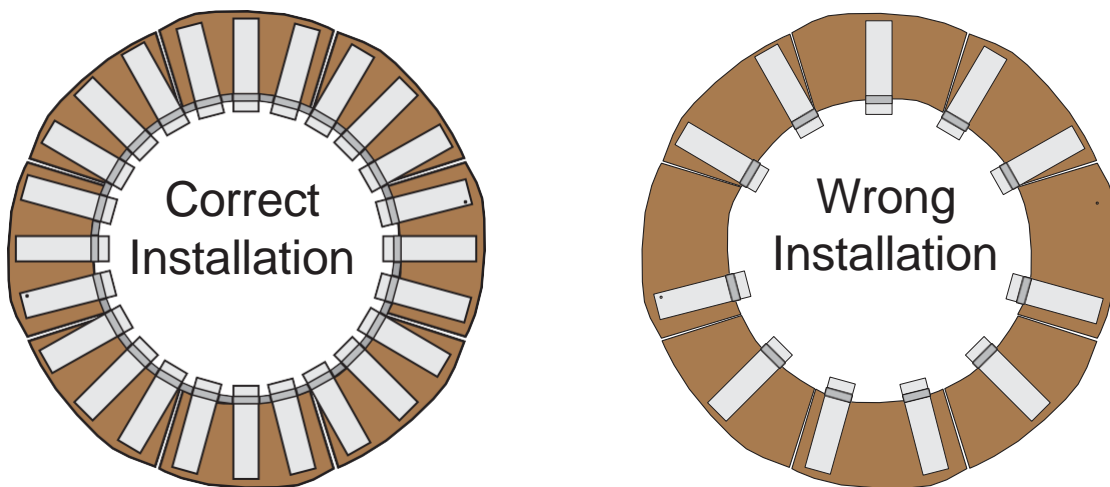

Fig. 5 FLEXFRAME round installation

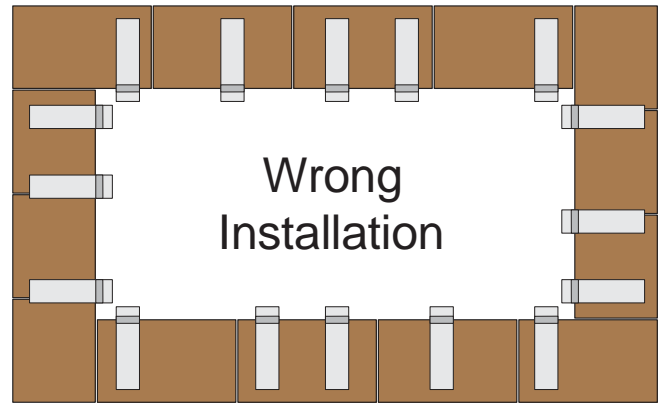
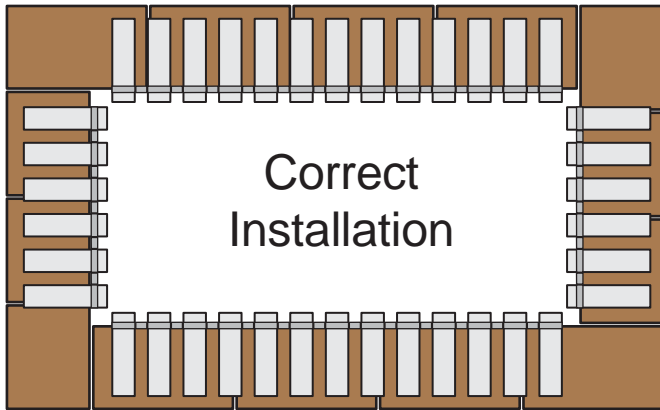

Fig. 6 FLEXFRAME square/rectangle installation

STEP 4:

Double check the minimum height above ground level before installing the fire pit. Complete the installation by installing a fire pit, pan or disc on the lip area of the FLEXFRAME (See Fig. 7 and Fig. 8). After test fire is complete cover the burner with media as described in the fire pit installation manual.



Fig. 7 FLEXFRAME complete



Fig. 8 FLEXFRAME shown with fire pit installed

FOR TECHNICAL SERVICE, CALL: (800) 966-8126

AMD Direct, Inc.
 17322 Gothard St
 Huntington Beach, CA 92647
 Web Site: www.firegearoutdoors.com

Manual changes often occur, ensure to check the Firegear Outdoor website for any recent updates and warranty information.